



**SANY ROBOTICS TECHNOLOGY CO., LTD.**

Address: No. 21, East Plant Area, Sany Industrial Park,  
Changsha County, Changsha City, Hunan Province

Post Code: 410100

Tel: 400-810-0318

FOLLOW US : SANY FORKLIFT



[www.sanyroboticsglobal.com](http://www.sanyroboticsglobal.com)

**UNMANNED PRODUCTS OF SANY ROBOTICS  
PRODUCT MANUAL**

## SPECTRUM OF AUTOMATED PRODUCTS OF SANY ROBOTICS

### INDOOR AND OUTDOOR AUTOMATED COUNTERBALANCE FORKLIFT



### AUTOMATED STACKING FORKLIFT

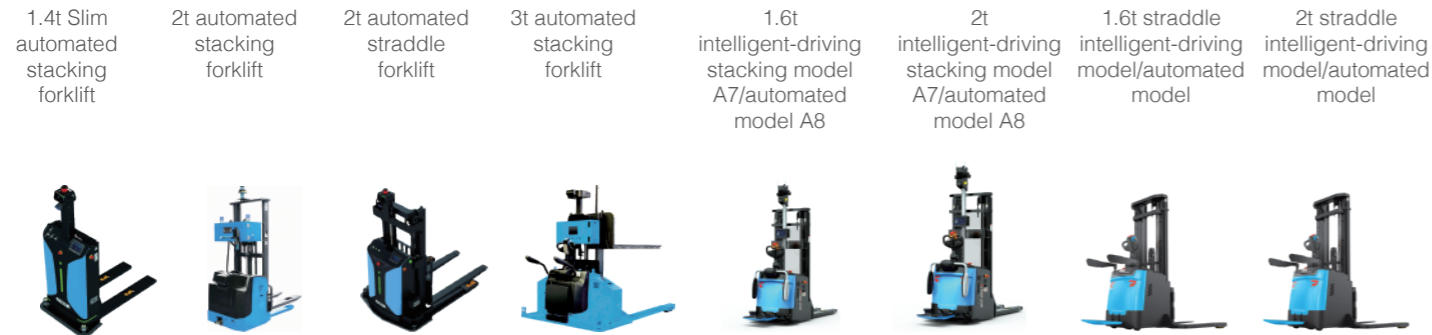

### AUTOMATED MATERIAL HANDLING FORKLIFT

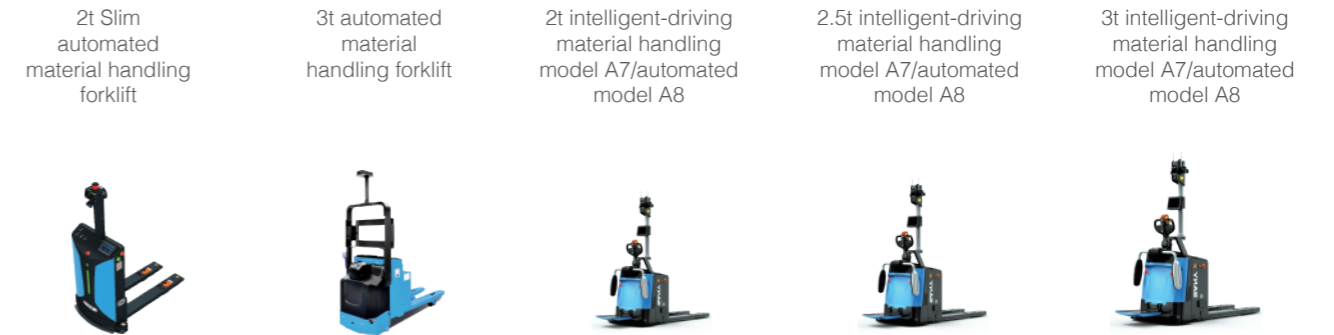

### UNIT LOAD AGV



### LITHIUM BATTERY AGV



# TYPICAL APPLICATION SCENARIOS: CUSTOMIZED DEVELOPMENT FOR MULTIPLE COMPLEX APPLICATION SCENARIOS, LEADING THE INDUSTRY

1

## DENSE STORAGE

- **Model:** 2t material handling, 1.5t Slim automated stacking forklift
- **Challenges:** Narrow aisles, non-standard pallets, and high throughput
- **Technology:** Perceived safety, pallet detection, dynamic obstacle avoidance



2t automated material handling forklift



1.5t Slim automated stacking forklift

2

## INDOOR HIGH-PRECISION STACKING

- **Model:** 2t stacking forklift, 2t Slim indoor counterweight forklift
- **Challenges:** multi-layer stacking, stack collision prevention, accuracy ±5mm
- **Technology:** Multi-source fusion safety, stacking four-layer stacking safety protection, autonomous stacking learning, pallet detection



2.5t indoor and outdoor counterweight forklift



2t Slim indoor counterweight forklift

3

## TRUCK HANDLING

- **Model:** 2.5t, 4t indoor and outdoor counterweight forklift
- **Challenges:** unfamiliar load carriers, complex man-machine operating environment, throughput
- **Technology:** Vision foundation model, chassis-payload coordinated control, unfamiliar load carrier recognition, optimal pallet loading solution



2.5t indoor and outdoor counterweight forklift



4t indoor and outdoor counterweight forklift

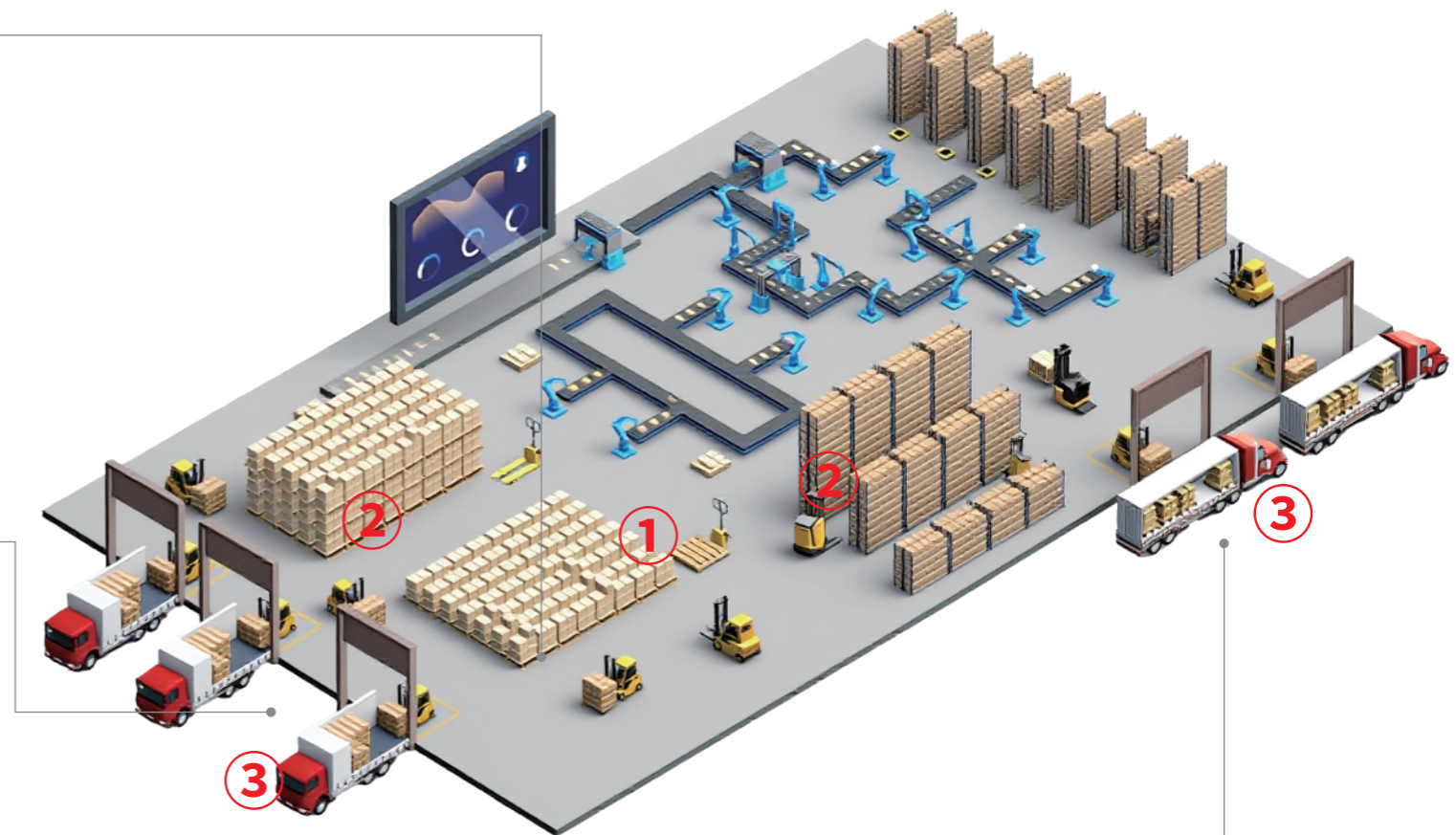

## KEY TECHNOLOGY

### 360 SAFETY



### EXTREME HIGH-PRECISION THREE-DIMENSIONAL STACKING, WITH 0 ERRORS

Four-layer stacking calibration protection, deep autonomous learning, with a success rate > 99%

It utilizes 3D SLAM + vision fusion, employing deep learning and cavity recognition algorithms to guarantee full-process inspection during stacking, thereby achieving high-precision, three-dimensional palletization.



### 3D SLAM NAVIGATION

3D SLAM adopts the 3D point cloud depth information to estimate the 6-DOF vehicle body position and pose, reducing the error caused by the plane assumption, making it more stable in the changing environment of the scenario, applicable to the environmental change rate within 30%, and improving the positioning accuracy.

#### 2D SLAM

Planar two-dimensional point cloud can not deal with height changes, with drifted positioning

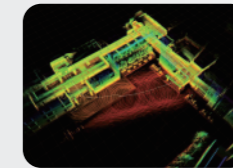

#### 3D SLAM

3D point cloud and grid map  
Indoor and outdoor complex terrain  
Improved mapping and positioning robustness

### HIGH-PRECISION THREE-DIMENSIONAL STACKING, WITH 0 ERRORS

• Non-standard pallet detection for stable handling

Rich pallet model library, rapid pallet scanning and modeling, adaptive handling  
Pallet adaption error range:  $\pm 100\text{mm}$ ,  $\pm 10^\circ$

Standard container

Coverage of  
**100%**

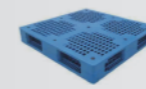

Non-standard container

Coverage rate of  
**60%**

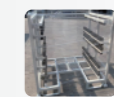

## ASSET MANAGEMENT SYSTEM (AMS)

The asset management system possesses the capability to manage a fleet of over 1,000 vehicles. It supports docking with upper-level systems like MES and WMS to execute point-to-point transport tasks, docking with PLC control systems of machines and conveyor lines for automatic loading/unloading, and docking with equipment such as roller shutters, elevators, and lifts to enable cross-area and cross-floor automated handling.

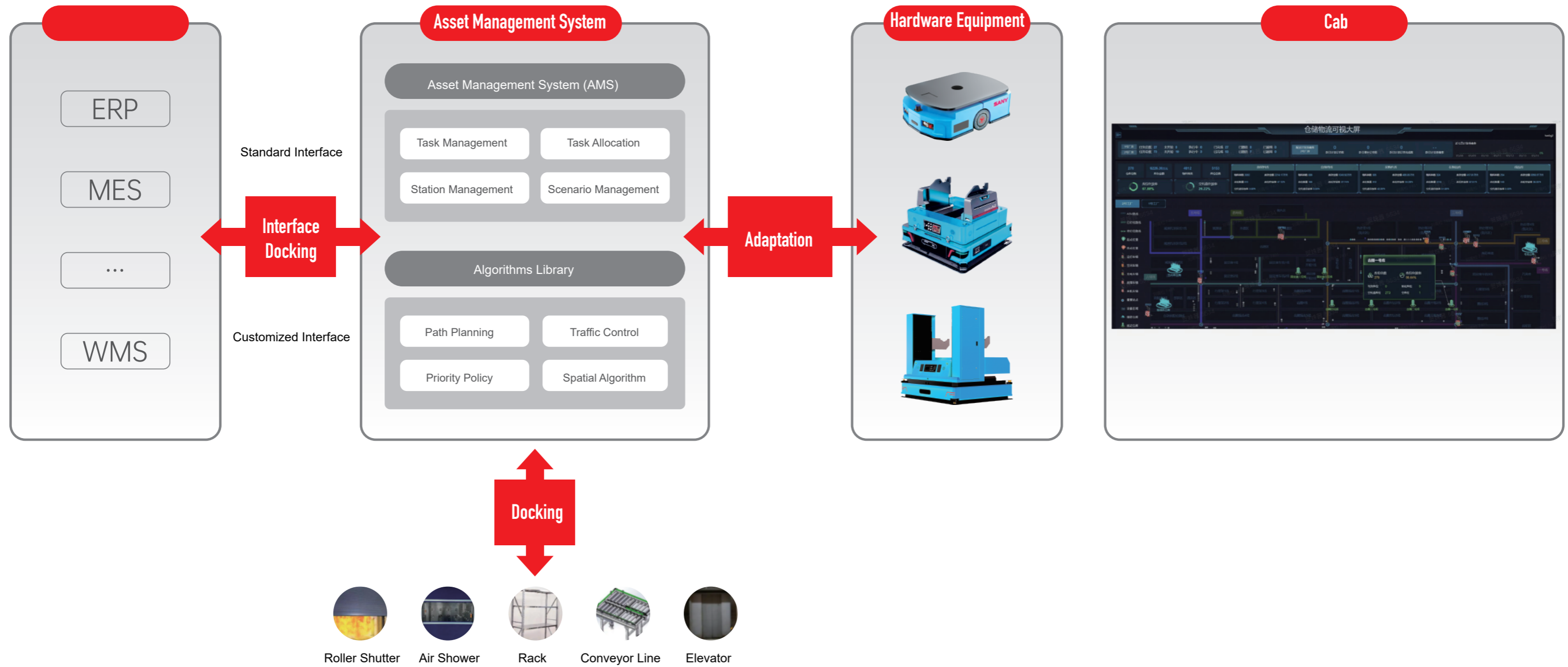

# MATERIAL HANDLING ROBOT SCB20/25/30A7 INTELLIGENT-DRIVING MODEL / A8 AUTOMATED MODEL

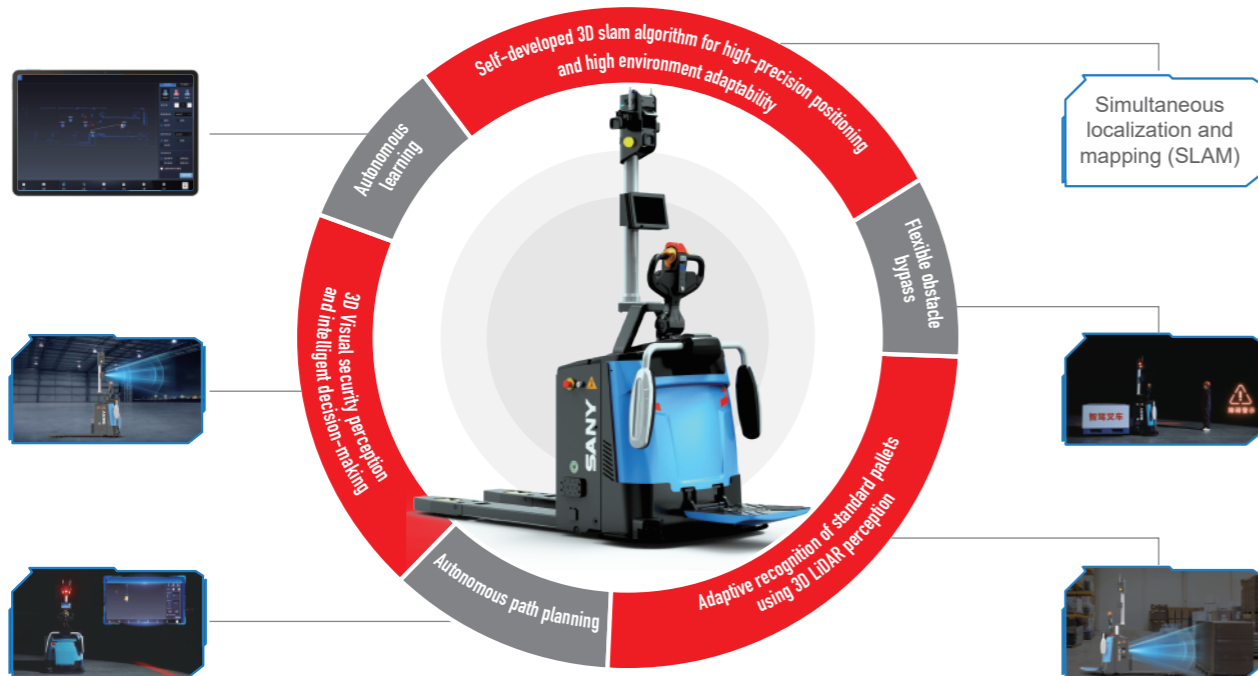

## REDUCING COST, INCREASING EFFICIENCY, SAVING MANPOWER AND LABOR

- Cost: A7 vs conventional AGV ↓ 30%
- Efficiency and capacity: A7 vs conventional AGV ↑ 30%

## MANUAL/AUTOMATED DRIVING

It integrates automated and manual driving, easy to switch, flexible operation, and can meet the needs of diverse operation scenarios

## LOW INVESTMENT AND HIGH RETURN

Cost-effective material handling robot in the industry

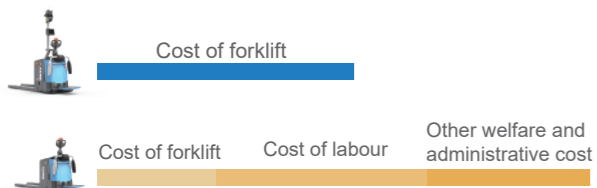
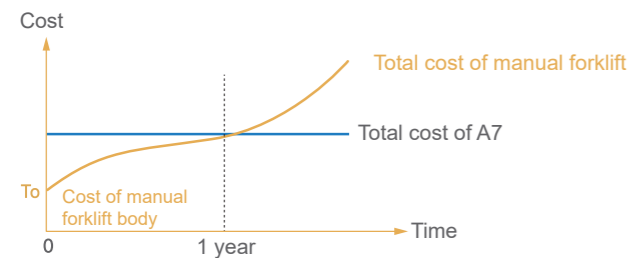

Calculation method: Total cost = Cost of forklift body + Labor cost (2 shifts per day) + other welfare and administrative cost



## HIGH SAFETY

- IP67 Protection of core components
- Comprehensive omni-directional safety protection 3D camera + 2D lidar + physical safety bumper



## HIGH EFFICIENCY

- Charging for 2 hours to work for 8 hours
- Drive with high speed ratio, with gradeability of 10%



## MEET APPLICATION MULTI-SCENARIOS

Designed for logistics handling scenarios, being a market changer for 1 million manual forklifts.

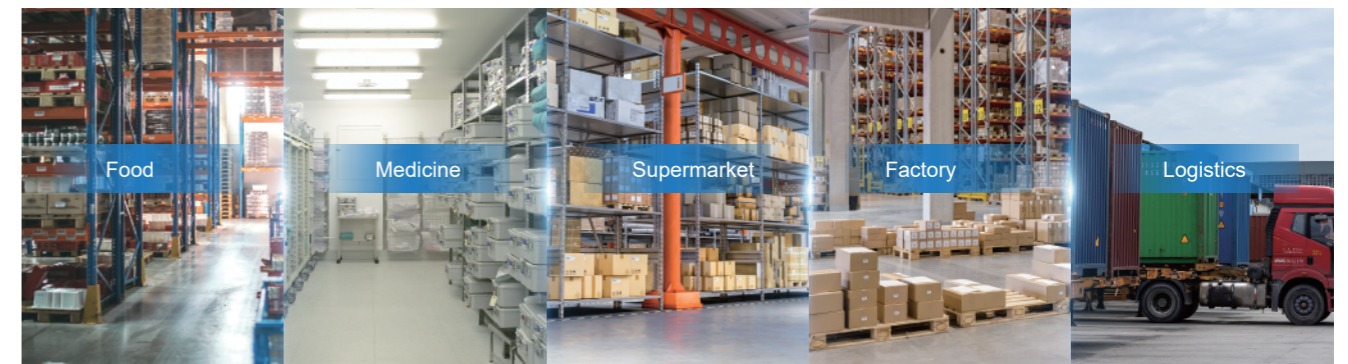

## INTELLIGENT-DRIVING PARAMETERS

Charging mode	Manual (standard) / automated (optional)
	Bottom obstacle avoidance radar (standard)
	Bumper strip (standard)
	3D obstacle avoidance camera (standard)
Driving safety	Tooth tip anti-collision photoelectric sensor (standard) / radar (optional)
	Audible and visual warning (standard)
Human-machine interaction	Emergency stop button (standard)
	HMI (standard) / IPad (optional)
Pallet pose detection	3D lidar (standard)
Positioning and navigation	3D lidar (standard)

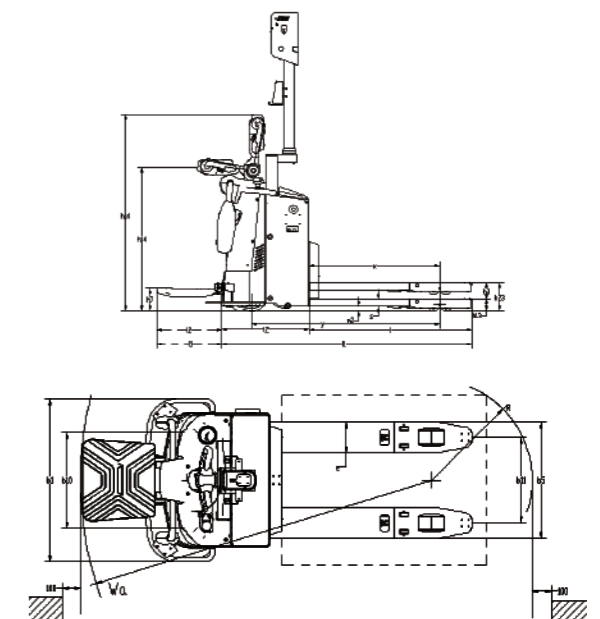

## INDOOR AND OUTDOOR AUTOMATED COUNTERBALANCE FORKLIFT SCP20/25/30/35/40 C9



10000m<sup>2</sup> warehouse

**12,000** pallets  
Traditional forklift



**30,000** pallets  
Sany automated forklift

Manual operation/automated operation

Up to **4** layers  
Old hand (with blind spot)



**5** layers  
Sany automated forklift

**5 layers + 2t + 8.5m**

Break through automated stacking impossibility, being the world first

**Self-adaptation 0 error**

3D laser + vision-based cage detection algorithm with stacking success rate of **100%**

**Standard container coverage of 100%**

Rich pallet model library  
Quick pallet scanning and modeling

**Millimeter-level accuracy**

Dual 3D lidar + 3D vision + RTK sensor integrated with dual 3D SLAM AI algorithm for high-precision positioning

**Extreme active safety**

3D laser + 3D camera + 2D laser + safety bumper for safety perception and intelligent decision

**High adaptation**

Allowable dynamic environmental change rate of **90%**, including indoor and outdoor, narrow roadway, rain, snow and fog, and low obstacles

## SANY AGV (AUTOMATED GUIDED VEHICLE)

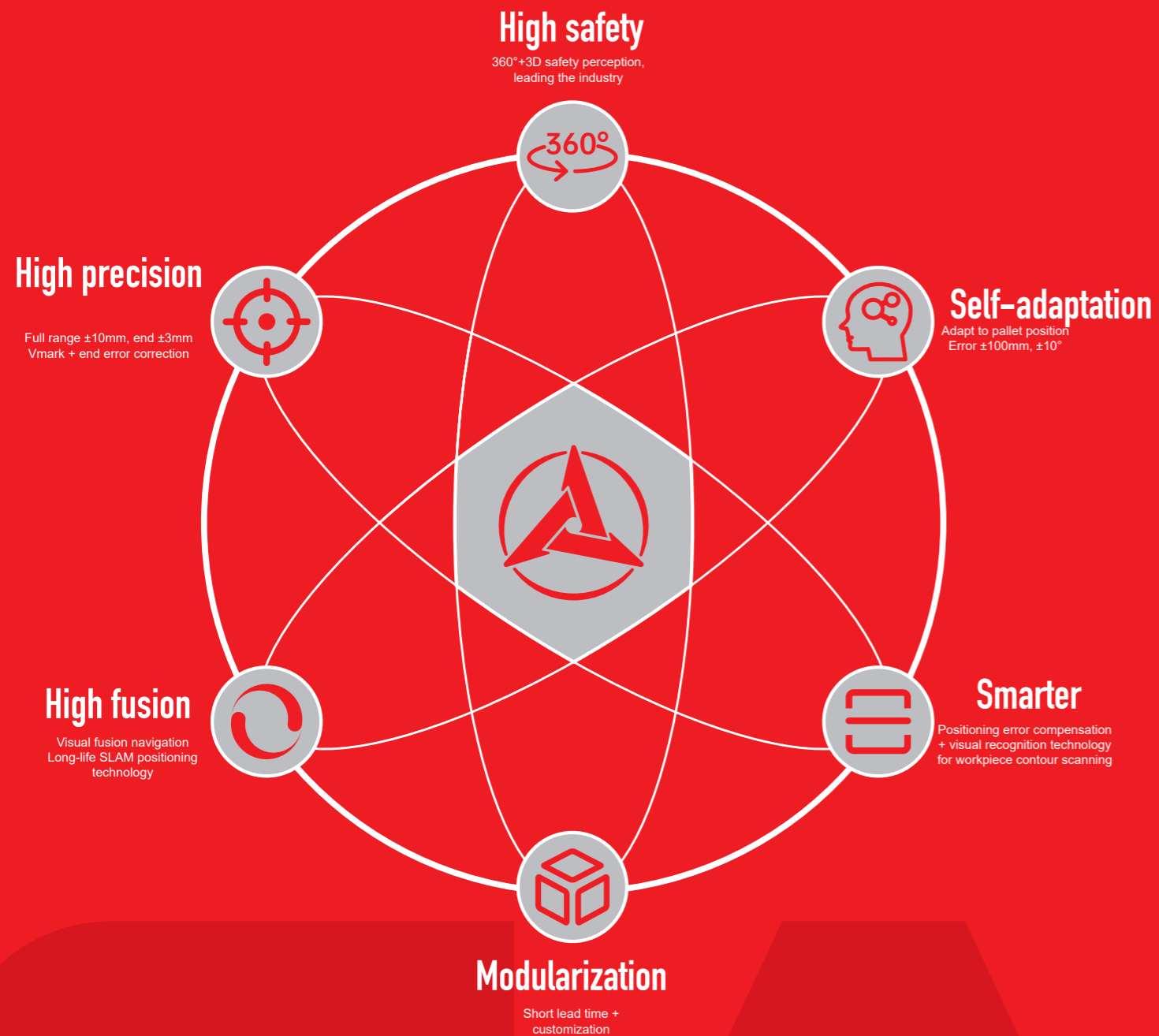

### LIGHT-DUTY UNIT LOAD AGV

Its low-profile chassis slides underneath racks or pallets and transports them by means of a lifting mechanism; generally, the load is not more than 1.5 t; it can transport loads such as pallets and material racks. Its top module is typically a lift-and-rotate mechanism, and it can be customized with roller or chain conveyors for docking with production lines, which is commonly differentially driven, with a speed of 1.5 m/s.

600kg unit load AGV



1t unit load AGV

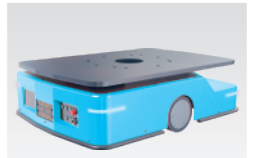

### HEAVY-DUTY UNIT LOAD AGV

AGV slides underneath materials or pallets and transports them by means of a lifting mechanism; generally, the load is more than 2t, and even 40t and above; it can transport loads directly or by carrying material racks. Its top module is typically a lifting mechanism, and it is commonly equipped with multiple steering wheels for drive, at a speed of 0.5-1 m/s.

2/3/5t unit load AGV

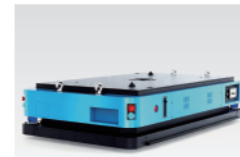

10t unit load AGV

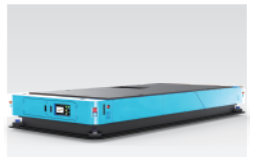

### LITHIUM BATTERY AGV

It is primarily designed for foil material handling in battery cell production, representing a customized AGV solution for specialized scenarios. This includes V-block AGVs for the front-end processes, under-ride AGVs for the back-end processes, as well as cantilever AGVs and offline forklift AGV, all of which must meet cleanroom production standards, preventing the exposure of metals like copper, zinc, and cadmium.

1.5t V-block AGV



2t V-block AGV



3.5t V-block AGV

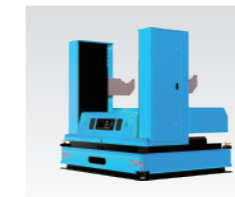

1.5t lithium battery unit load AGV



## TYPICAL CASE: A POWER-BATTERY INTELLIGENT LOGISTICS PROJECT

### INTRODUCTION TO THE PROJECT

This project automates the full-process material handling for anode and cathode foil electrode manufacturing at a leading domestic lithium battery producer. The scope encompasses: raw substrate transport, loading/unloading for gravure printing/coating, loading/unloading for cold pressing, feeding for die-cutting, and transferring finished die-cut pieces to the winding assembly line.

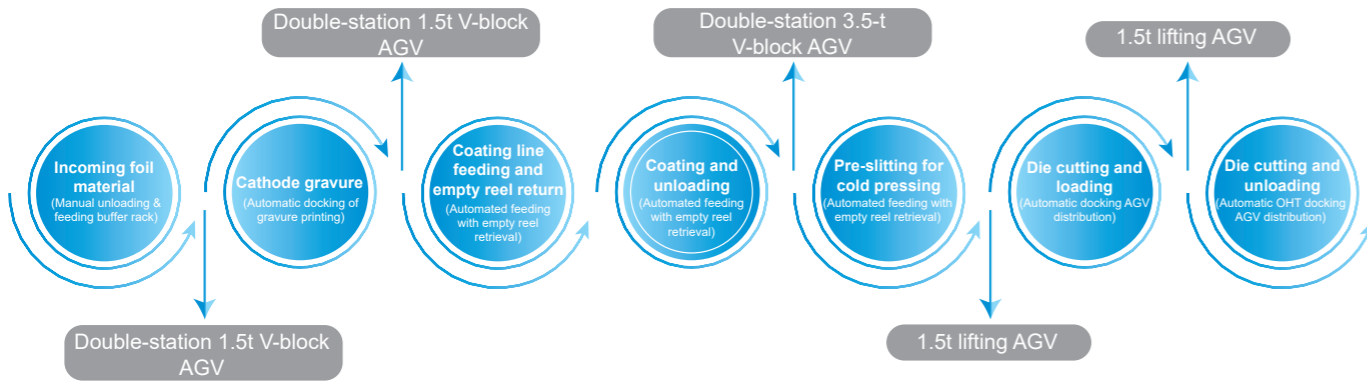

#### Pain Points of Client

○ Equipment docking accuracy is high, requiring  $\pm 3\text{mm}$ , and it is difficult for manual placement, with high error rate

○ The production process is cumbersome, the logistics scheduling logic is complex, and it is difficult to ensure the timeliness and accuracy of material distribution manually

#### Features of the scheme

✓ The integration of local contour positioning and vehicle adaptive control technology enhances the AGV docking accuracy with equipment. Coupled with a stereo 3D camera, it enables collision detection for rolled materials  
 ✓ The lidar natural feature navigation solution eliminates the need for floor-mounted guide markers, significantly reducing on-site installation effort and complexity

✓ Docking with MES system at the same plant level, ensure the smooth flow of information while the material flows automatically  
 ✓ Intelligent dispatching system accurately calculates avoidance resources, so that AGVs can avoid each other efficiently and safely, with more than 300 AGVs of various types to be dispatched at the same time



Logistics and distribution link  
To be completed by manual forklift

**Prior to implementation**

Manual loading onto the production line has an error rate of 2-3 per 100 cycles

**Rate of automation**

Material transfer automation rate of

# 100%

Automatic docking success rate of AGV of

# 99.5%

**Accuracy**

# 300+

number of dispatching devices supported

Industry-first simultaneous

V-block pick-and-place technology

**After implementation**

## TYPICAL CASE: INTELLIGENT WAREHOUSING AND LOGISTICS SYSTEM PROJECT OF ZTT EQUIPMENT CABLE CO., LTD.

### INTRODUCTION TO THE PROJECT

It is a key project of ZTT Equipment Cable Co., Ltd. to continuously implement the intelligent manufacturing strategy, which is the key for the company to realize leap-forward advancing from traditional warehousing logistics to modern automation, 5G informatization and intelligent logistics.

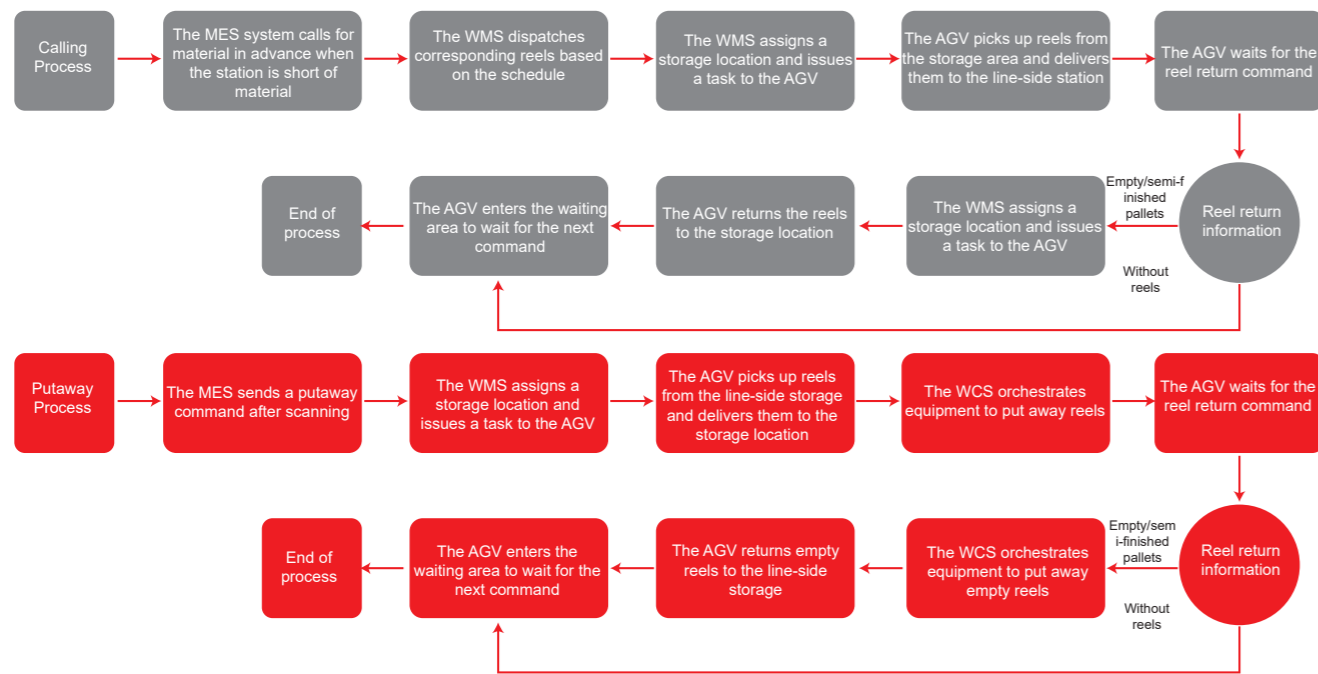

#### Pain Points of Client

- Various reel specifications
- A lot of time spent in searching for materials in the storage
- Low delivery timeliness and accuracy
- Due to space constraints in the old plant, the flat storage method cannot meet the growing demand for buffer locations under increasing production capacity

#### Features of the scheme

- Intelligent warehousing and logistics integrated solutions, with industry-adapted material management system
- Customized forklift AGV body, adapting to a variety of reel specifications, featuring automatic and flexible connection
- Smart high-bay ASRS and the double-deep storage rack, increasing buffer location capacity, and connecting with AGVs to achieve automated inbound/outbound and line-side delivery
- A combined storage system solution to efficiently meet the storage demands of various logistics processes

**Storage location capacity:** Only 500 reel storage locations → Increased to 1500 reel storage locations **200% ↑**

**Delivery efficiency:** Average 80 reels transferred per person per day → Average 120 reels transferred per person per day **50% ↑**

**Production capacity increase:** Average machine changeover waiting time of 5 minutes per occurrence → Issuing distribution tasks in advance to increase equipment uptime to **70%**

## CLASSIC CASE: AUTOMATIC HANDLING PROJECT FOR AUTOMOBILE GLASS

### INTRODUCTION TO THE PROJECT

The glass assembly and curing process of a Fortune 500 company adopts manual forklifts for material distribution and stacking. There are problems such as harsh operating environment (high curing temperature and odor from chemical reaction), high risk of manual stacking, and high cost, which limit capacity expansion. The client's request is to establish an automated material handling system with core requirements including double-deep stacking, high-density storage, and a docking accuracy of  $\pm 5\text{mm}$  for cavity operations.



## CLASSIC CASE: AUTOMATED HANDLING PROJECT FOR THE DOWNSTREAM STAGE OF THE CHEMICAL FIBER INDUSTRY

### INTRODUCTION TO THE PROJECT

A leading enterprise in the chemical fiber industry requires 24/7 material distribution in its downstream processes. Its current reliance on manual forklift operations suffers from high costs, low efficiency, safety concerns, and a high error rate. The company's objective is to overhaul this manual handling by implementing a comprehensive intra-facility logistics control system.

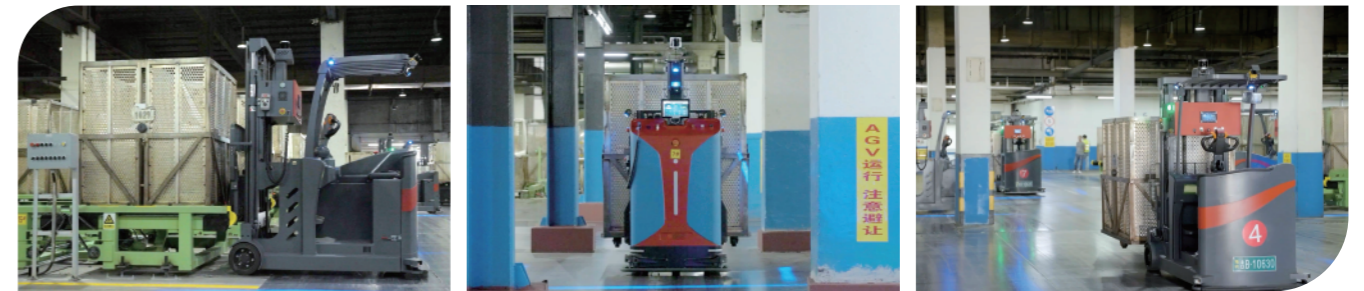

#### Pain Points of Client

- © Workers can not work for a long time due to harsh environment
- © High docking accuracy of  $\pm 5\text{mm}$ , which cannot be met by most manufacturers in the industry

#### Automated Forklift Solution

- ✓ Triggered by tasks from a PDA, automated forklifts perform automated transport, which is configured with a logistics management system to achieve high-density storage with double-deep racking
- ✓ It leverages vision fusion technology, employing algorithms for pallet cavity extraction and point cloud matching. This enables it to handle challenging scenarios such as stacking of stacked cages and palletized loads

#### Pain Points of Client

- © It utilizes steel plates for flooring on site, with issues including wide gaps between segments, an uneven surface, and deformation of the plates during traveling under load
- © The information chain spans the entire process from doffing and setting to long and short stroking, involving hundreds of RFID data points and demanding high accuracy
- © High docking accuracy of  $\pm 10\text{mm}$

#### Automated Forklift Solution

- ✓ It utilizes 3D SLAM technology to construct a three-dimensional map, enabling global positioning for the automated forklift with an accuracy of  $\pm 10\text{mm}$
- ✓ By integrating tow truck pose detection with end-effector perception technology, it achieves a stable and reliable docking accuracy of  $\pm 5\text{mm}$  with the tow truck
- ✓ It leverages vision fusion technology, employing algorithms for pallet cavity extraction and point cloud matching. This enables it to handle challenging scenarios such as stacking of stacked cages and palletized loads

## TRUST IN SANY'S SMART WAREHOUSING AND LOGISTICS SOLUTIONS!

### Vehicle/Transportation Industry



### New Energy Industry



### Intelligent Equipment Industry



### New Material Industry



### New Infrastructure Industry



### Shipping and Marine Equipment Manufacturing



## STANDARD PARAMETER LIST - AUTOMATED FORKLIFT



Vehicle type	1.4t Slim Automated Stacking Forklift	2t automated stacking forklift	2t automated straddle forklift	3t automated stacking forklift
Dimensions (L x W x H)	1700×980×2035mm	2960×1120×2200mm	2277×2176×2200mm	2419×1360×2200mm
Turning radius	1200mm	1665mm	1815mm	1800mm
Service weight	680kg	1800kg	1450kg	2500kg
Rated load capacity	1400kg	2000kg	2000kg	3000kg
Lifting height	1600mm	2500mm	2500mm	2500mm
Navigation mode	Laser Slam/reflector			
Loaded speed	1m/s	1m/s	1m/s	1m/s
No-load speed	1.5m/s	1.5m/s	1.5m/s	1.5m/s
Maximum acceleration	≥0.5 m/s <sup>2</sup>	≥0.5 m/s <sup>2</sup>	≥0.5 m/s <sup>2</sup>	≥0.5 m/s <sup>2</sup>
Positioning accuracy	≤±10mm, ±1°			
Battery type	Lithium iron phosphate			
Battery capacity	24V 105Ah	24V 200Ah	24V 200Ah	24V 300Ah
Endurance	6-8h			
Charging time	≤2h			
Movement mode	Forward travel, backward travel, turning			
Communication mode	WIFI or 5G			
Gradeability	3%			
Safety protection	360° safety lidar, contact-based safety, stereoscopic 3D safety camera, emergency stop switch			
Equipment status	Power and equipment status prompted by display, with audible and visual alarm			
Working environment	Ambient temperature: 0 °C ~ 45 °C; humidity: 15% ~ 90%, no condensation			



2t automated Slim material handling forklift	3t automated material handling forklift	1.5t automated indoor counterweight forklift	2t automated indoor counterweight forklift
1625×1044×2200mm	2270×800×2200mm	3265×1170×2200mm	4080×1211×2300mm
1343mm	1810mm	1730mm	1800mm
535kg	750kg	2350kg	3000kg
2000kg	3000kg	1500kg	2000kg
200mm	200mm	1600mm	3000mm
Laser Slam/reflector			
1m/s	1m/s	1m/s	1m/s
1.5m/s	1.5m/s	1.5m/s	1.5m/s
≥0.5 m/s <sup>2</sup>	≥0.5 m/s <sup>2</sup>	≥0.5 m/s <sup>2</sup>	≥0.5 m/s <sup>2</sup>
≤±10mm, ±1°			
Lithium iron phosphate			
24V 105Ah	24V 200Ah	24V 250Ah	24V 300Ah
6-8h			
≤2h			
Forward travel, backward travel, turning			
WIFI or 5G			
3%			
360° safety lidar, contact-based safety, stereoscopic 3D safety camera, emergency stop switch			
Power and equipment status prompted by display, with audible and visual alarm			
Ambient temperature: 0 °C ~ 45 °C; humidity: 15% ~ 90%, no condensation			

## STANDARD PARAMETER LIST - AUTOMATED FORKLIFT



Vehicle type	2t material handling forklift A7/A8	2.5t material handling forklift A7/A8	3t material handling forklift A7/A8	1.6t Stacking forklift A7/A8
Dimensions (L x W x H)	2170*960*2330mm	2170*960*2330mm	2170*960*2330	2120*960*2560
Turning radius	1700/2060mm	1700/2060mm	1700/2060mm	1670mm
Service weight	710kg	720kg	720kg	1420kg
Rated load capacity	2000kg	2500kg	3000kg	1600kg
Lifting height	120mm	120mm	120mm	2500-3600mm
Navigation mode	3D laser Slam/reflector			
Loaded speed	2m/s	2m/s	2m/s	2m/s
No-load speed	2m/s	2m/s	2m/s	2m/s
Maximum acceleration	0.41 m/s <sup>2</sup>	0.41 m/s <sup>2</sup>	0.41 m/s <sup>2</sup>	0.5 m/s <sup>2</sup>
Positioning accuracy	≤ ±10mm, ±1°			
Battery type	Lithium iron phosphate			
Battery capacity	48V 100Ah	48V 100Ah	48V 100Ah	48V 100Ah
Endurance	6-8h			
Charger	Standard 48V50A (High-level configuration 48V100A, capable of automatic charging)	Standard 48V50A (High-level configuration 48V100A, capable of automatic charging)	Standard 48V50A (High-level configuration 48V100A, capable of automatic charging)	Standard 48V50A (High-level configuration 48V100A, capable of automatic charging)
Charging time	2 hours for standard configuration, 1 hour for high-level configuration			
Movement mode	Forward travel, backward travel, turning			
Communication mode	WIFI or 5G			
Gradeability	Full load/no load: 10/16%	Full load/no load: 10/16%	Full load/no load: 10/16%	Full load/no load: 10/16%
Safety protection	360° safety lidar, contact-based safety, stereoscopic 3D safety camera, emergency stop switch			
Equipment status	Power and equipment status prompted by display, with audible and visual alarm			
Working environment	Ambient temperature: -5 °C ~ 40 °C, no condensation at altitude less than 2000m			
Minimum ground clearance	85mm	85mm	85mm	90mm
Fork size	55/180/1150	55/180/1150	55/180/1150	65/185/1150



2t material handling forklift A7/A8	2t counterweight	2.5t counterweight	4t counterweight
2120*960*2560mm	2660*1230*2260mm	2660*1230*2260mm	3000*1310*2260mm
1670mm	2550mm	2550mm	2850mm
1445kg	3700kg	4000kg	6500kg
2000kg	2000kg	2500kg	4000kg
2500-3600mm	3000-6000mm	3000-6000mm	3000-7000mm
3D laser Slam/reflector	3D laser slam/3D laser slam + RTK		
2m/s	3m/s	3m/s	3m/s
2m/s	3.5m/s	3.5m/s	3.5m/s
0.5 m/s <sup>2</sup>	0.5 m/s <sup>2</sup>	0.5 m/s <sup>2</sup>	0.5 m/s <sup>2</sup>
≤ ±10mm, ±1°			
Lithium iron phosphate			
48V 100Ah	96v/230Ah	96v/230Ah	320/163Ah
6-8h			
Standard 48V50A (High-level configuration 48V100A, capable of automatic charging)	Standard 96V200A	Standard 96V200A	50-750V100A(30kw)
2 hours for standard configuration, 1 hour for high-level configuration	Standard 2 hours		
Forward travel, backward travel, turning			
WIFI or 5G			
Full load/no load: 8/16%	Full load/no load: 15/15%	Full load/no load: 15/15%	Full load/no load: 15/15%
360° safety lidar, contact-based safety, stereoscopic 3D safety camera, emergency stop switch			
Power and equipment status prompted by display, with audible and visual alarm			
Ambient temperature: -5 °C ~ 40 °C, no condensation at altitude less than 2000m			
85mm	40m	40m	50m
55/180/1150	40/150/1070 (Length is adjustable)	40/150/1070 (Length is adjustable)	40/150/1070 (Length is adjustable)

## STANDARD PARAMETER TABLE - UNIT LOAD AGV



Vehicle type	600kg unit load AGV	1t unit load AGV	2t unit load AGV
Dimensions (L×W×H)	894×634×300mm	1210×892×355mm	1450×1050×380mm
Turning radius	1096mm	1504mm	1791mm
Service weight	138kg	332kg	370kg
Rated load capacity	600kg	1000kg	2000kg
Lifting height	60mm	60mm	100mm
Navigation mode	Laser Slam/QR code		
Loaded speed	1.5m/s	1.5m/s	1m/s
No-load speed	1.5m/s	1.5m/s	1m/s
Maximum acceleration	0.5m/s <sup>2</sup>	0.5m/s <sup>2</sup>	0.5m/s <sup>2</sup>
Positioning accuracy	≤ ±10mm, ±1°		
Battery type	Lithium iron phosphate		
Battery capacity	48V 23Ah	48V 40Ah	48V 60Ah
Endurance	6-8h		
Charging time	≤ 2h		
Movement mode	Forward travel, backward travel, turning, spinning		
Communication mode	WIFI or 5G		
Gradeability	3%		
Safety protection	Front and rear safety lidar, contact-based safety, emergency stop switch	360° safety lidar, contact-based safety, emergency stop switch	
Equipment status	Power and equipment status prompted by display, with audible and visual alarm		
Working environment	Ambient temperature: 0 °C ~ 45 °C; humidity: 15% ~ 90%, no condensation		

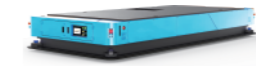
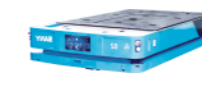
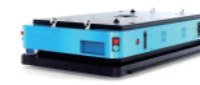

3t unit load AGV	5t unit load AGV	10t unit load AGV
2047×1247×470.5mm	2710×1560×450mm	4470×2080×598mm
2397mm	3127mm	4931mm
1080kg	1960kg	3352.4kg
3000kg	5000kg	10000Kg
120mm	100mm	0mm
Laser Slam/Magnetic tape		
0.8m/s	0.5m/s	0.5m/s
1m/s	0.5m/s	0.5m/s
0.5m/s <sup>2</sup>	0.25m/s <sup>2</sup>	0.25m/s <sup>2</sup>
≤ ±10mm, ±1°		
Lithium iron phosphate		
48V 100Ah	48V 206Ah	48V 400Ah
6-8h		
≤ 2h		
Forward travel, backward travel, turning, spinning, lateral movement		
WIFI or 5G		
3%		
360° safety lidar, contact-based safety, emergency stop switch		
Power and equipment status prompted by display, with audible and visual alarm		
Ambient temperature: 0 °C ~ 45 °C; humidity: 15% ~ 90%, no condensation		

## STANDARD PARAMETER TABLE - LITHIUM BATTERY AGV



Vehicle type	1.5t double-V-block AGV	2t double-V-block AGV
Dimensions (L x W x H)	2100×1600×1045mm	1650×1750×1220mm
Turning radius	2641mm	2406mm
Service weight	1200kg	1500kg
Rated load capacity	1500kg	2000kg
Lifting height	720mm	590mm
Navigation mode	Laser Slam/QR code/magnetic tape	
Loaded speed	1m/s	0.8m/s
No-load speed	1m/s	0.8m/s
Maximum acceleration	0.5m/s <sup>2</sup>	0.4m/s <sup>2</sup>
Positioning accuracy	≤±10mm, ±1°	
Battery type	Lithium iron phosphate	
Battery capacity	48V 125Ah	48V 125Ah
Endurance	6-8h	
Charging time	≤2h	
Movement mode	Forward travel, backward travel, turning, lateral movement, spinning	
Communication mode	WIFI or 5G	
Gradeability	3%	
Safety protection	360° safety lidar, contact-based safety, emergency stop switch	
Equipment status	Power and equipment status prompted by display, with audible and visual alarm	
Working environment	Ambient temperature: 0 °C ~ 45 °C; humidity: 15% ~ 90%, no condensation	

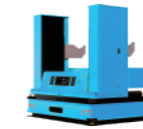

3.5t double-V-block AGV	1.5t unit load AGV
2200×1600×1591mm	1196×915×680mm
2721mm	1506mm
2000kg	450kg
3500kg	1500kg
200/900mm	60mm
Laser Slam/QR code/magnetic tape	Laser Slam/QR code
0.8m/s	1m/s
0.8m/s	1.5m/s
0.4m/s <sup>2</sup>	0.5m/s <sup>2</sup>
≤±10mm, ±1°	
Lithium iron phosphate	
48V 125Ah	48V 125Ah
6-8h	
≤2h	
Forward travel, backward travel, turning, lateral movement, spinning	
WIFI or 5G	
3%	
360° safety lidar, contact-based safety, emergency stop switch	
Power and equipment status prompted by display, with audible and visual alarm	
Ambient temperature: 0 °C ~ 45 °C; humidity: 15% ~ 90%, no condensation	